

EX-6 series

HITACHI

EX
1900



HYDRAULIC EXCAVATOR

- **Model Code** : EX1900-6
- **Engine Gross Power** : 810 kW (1 086 HP)
- **Operating Weight** : Backhoe : 192 000 kg
Loading Shovel : 191 000 kg
- **Backhoe Bucket** : PCSA Heaped : 4.4 - 12.0 m³
CECE Heaped : 3.8 - 10.6 m³
- **Loading Shovel Bucket** : PCSA Heaped : 11.0 - 15.0 m³

Ultra Large Sized Production from the Hitachi Gigantic Excavators

The Hitachi Giants Yield Amazing
Mining Production...
Setting a New Standard



SOLUTION GIANT

Giant-Sized Productivity Based on Hitachi's Theory of Evolution.

Each Hitachi generation listens to the needs of the work site and gives birth to an even-better new generation.



Powerful Single Engine— Ready for the task.

Time-proven Cummins diesel engine produces a total of 810 kW (1 086 HP) for handling the big excavation jobs.

- 810 kW (1 086 HP)

Emission Control Engine— Helping to protect our environment.

Conforms to U.S. EPA Tier II emission regulations.

Efficient E-P Control— Adjusts power output to the work being performed.

Hitachi's computer-aided Engine-Pump Control (E-P Control) coaxes optimum efficiency from the engine and hydraulic pumps. This innovative system senses load demand and controls engine and pump output for maximum operating efficiency.

Larger Bucket Provides High Work Capacity.

- Backhoe bucket : 12.0 m³
- Loading shovel bucket : 11.0 m³

Maximum Excavating Force.

- Backhoe : Arm crowd force (ISO) : 620 kN (63 200 kgf)
(SAE : PCSA) : 609 kN (62 100 kgf)
Bucket digging force (ISO) : 671 kN (68 400 kgf)
(SAE : PCSA) : 617 kN (62 900 kgf)
- Loading shovel : Arm crowding force : 710 kN (72 400 kgf)
Breakout force : 660 kN (67 300 kgf)

Large Bucket— Designed to enhance efficiency.

The large bucket has been shaped specifically to enhance scooping and loading operations. Its sharp tilt angle helps boost operating efficiency.

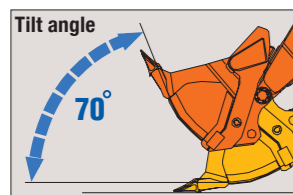

Productivity-Boosting Auto-Leveling Mechanism— One-lever leveling control.

This is another unique Hitachi function developed exclusively for more efficient leveling operations.

Note: Photos in this catalog may include optional equipment. They may also include custom-made options to meet specific user needs.



Bucket Passes to Dump Trucks

	HITACHI EH1700
Maximum Payload	108.4 ton
Load Capacity <small>(SAE 2:1 Heaped)</small>	60.3 m ³
Backhoe 12.0 m ³	5
Loading Shovel 11.0 m ³	6

SOLUTION GIANT

**More Than Durable —
Just Plain Tough**

Built-in toughness means the Hitachi will continue to get giant-sized jobs done fast.



Rigid Box Design— Resists bending and twisting forces.

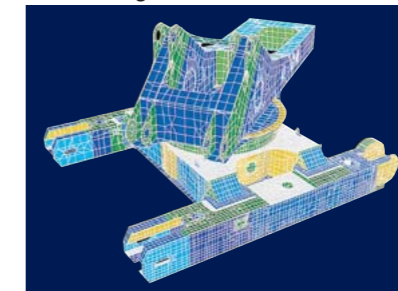

Computer-assisted analysis was used to check that the frame box can withstand heavy-duty excavation work.

Solid Cast Track Frame— More strength for this key area.

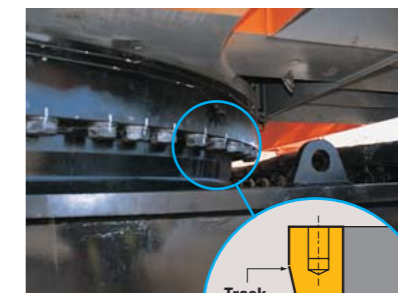

The track frame is cast as a solid unit and includes a flange for improved reliability. This non-welded design is used exclusively on large Hitachi models.

Strategically Positioned Oil Coolers— Helps keep oil temperatures

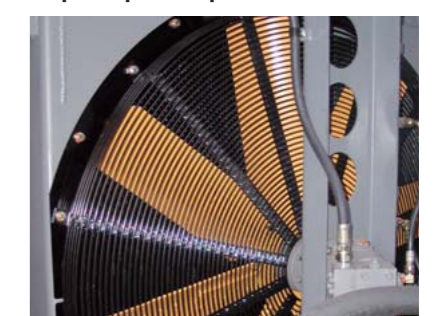

An oil cooler is used for optimal cooling efficiency. They are positioned far from the engine radiator for even better cooling potential.

High-Mounted Compact Travel Motors and Optional Travel Motor Guard— Help to boost durability at rugged work sites.



This design helps protect the travel motors from damage by rocks.



SOLUTION GIANT

Designed to Offer Comfort and Intelligence

Comfortable operator space and simplified maintenance, backed by Hitachi technologies and experience.

High Visibility 6.03 Meter Cab Height— Providing a clear view of the work area.

Gives the operator a clear view, even when a large 150 US ton class dump truck is being loaded. This high height and forward-sloping cab provides a view that boosts productivity.

Rugged Comfortable Cab— Protects the operator from falling objects.

Fluid filled elastic mounts help absorb vibration to provide durability and a comfortable ride. The top guard, conforming to OPG* level II (ISO), is provided on the cab roof.

*Operator Protective Guard

Efficient Cab Layout— All controls within natural reach of operator.

The ergonomic layout of the cab means the operator will do less stretching and reaching when operating the controls. This adds up to less operator fatigue and greater operating efficiency.

Electric Joystick Levers— Provides pleasant control with less fatigue.

Electric joystick control levers have a feather-touch allowing long periods of effortless operation. Its stroke is much shorter than that of hydraulic control.

Air Suspension Seat with Auto Operator Weight Adjuster.

The operator seat cushion can automatically be adjusted according to the operator weight. This is convenient for a machine operated by two or more operators.

Adjustable Sliding Cockpit— Moves to the best position for the operator.

The operator can adjust the position of the levers and the seat to custom fit his size and operating style.

Constant-Cab-Comfort Air Conditioner— Keeps the cab pressurized to keep out dust while maintaining comfortable temperature.

Intelligent Multi-Display Monitor provides machine data and operating status at a glance.

The operator can monitor machine conditions and operating status with a 10.5-inch color LCD. The controller provides instant fault diagnosis through all sensors, displaying warnings and countermeasures if failure arises.



Major Functions:

- Multiple meters, and alert symbols indication
- Alert/failure status, and countermeasures indication
- Snap-shot function that stores operating data, including five-minute operating data immediately before alerting, and succeeding one-minute data (temperatures, pressures, and more)
- Setting oil change intervals with alerting

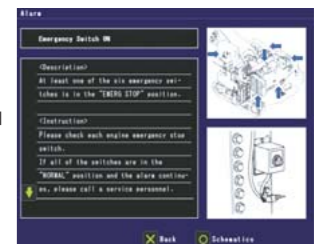

* Illustration shows a sample of the Emergency Switch.

Much more functions are provided to ease maintenance and servicing.

Outside Cameras (Option)— Enhances operating safety.

The operator can monitor around the machine, using four cameras (option) to eliminate blind spots.



SOLUTION GIANT

Designed to be Maintenable

Carefully engineered to allow full 24-hour operation.



Counterweight with Walkway— Easier access for maintenance.



A walkway around the entire counterweight provides easy access to key rear areas. This means faster and safer inspection and maintenance.

Folding Stairs with Wide Steps (Option).



Folding stairs is designed for easy access to the machine for servicing and maintenance.

Wide-Open Service Area— Provides the space needed for quick and easy inspection and maintenance.

This area is conveniently located at the center of the body and provides access to the engine as well as the hydraulic and electrical systems.



Easy Access and Maintenance—
Easy access speeds inspections and maintenance.

- | | |
|-----------------------------------|----------------------------------|
| 1 Diesel Engine | 13 Center Joint |
| 2 Pump Drive Unit | 14 Hydraulic Tank |
| 3 Hydraulic Pump x 6 | 15 Fuel Tank |
| 4 Hydraulic Oil Cooling Fan Motor | 16 Battery Unit |
| 5 Hydraulic Oil Cooler | 17 Lubricator |
| 6 Engine Radiator | 18 High-Pressure Strainer x 3 |
| 7 LTA Radiator | 19 Reserve Tank (Coolant) |
| 8 Fuel Cooler | 20 Air Filter x 2 (Outer/Inner) |
| 9 Pump Transmission Oil Cooler | 21 Muffler |
| 10 Engine-Pump Bulkhead | 22 Fuel Filter (Water Separator) |
| 11 Control Valve x 3 | 23 Cab |
| 12 Swing Device x 2 | 24 Ladder |
| | 25 Retractable-Type Ladder |

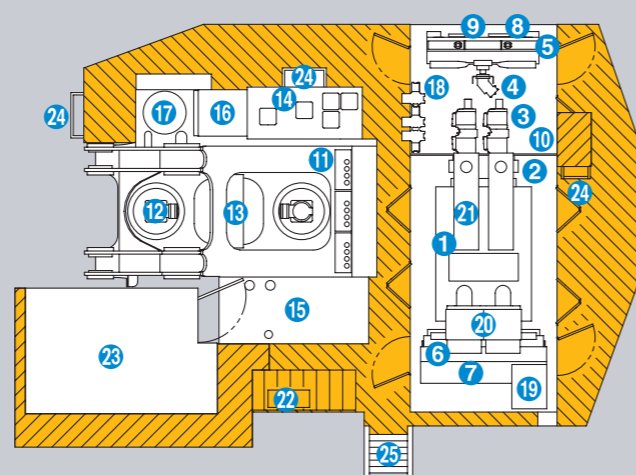

Auto Lubrication System Eliminates the need for manual lubrication.

This system automatically lubricates the front joint pins and swing circle. This eliminates cumbersome daily lubrication.

Easy-to-Replace Grease Drum Can— Designed to provide quick and easy grease drum can changes.

The compartment floor slides down to lower a drum for simple, easy replacement.



Convenient Centralized Filter System— Designed to make filter inspection and maintenance easier.

Centralized position means that inspection and maintenance can be performed quickly and easily.



The Centralized Lubrication System: Fast Filling System



Low Maintenance Dust Ejector— Automatically expels dust from the air cleaner.

This is one less time-consuming task during routine maintenance.

Contamination sensor— Alerts the operator of excessive contaminants in the oil.

This system detects accumulated contaminants that could cause damage and alerts the operator before trouble occurs.

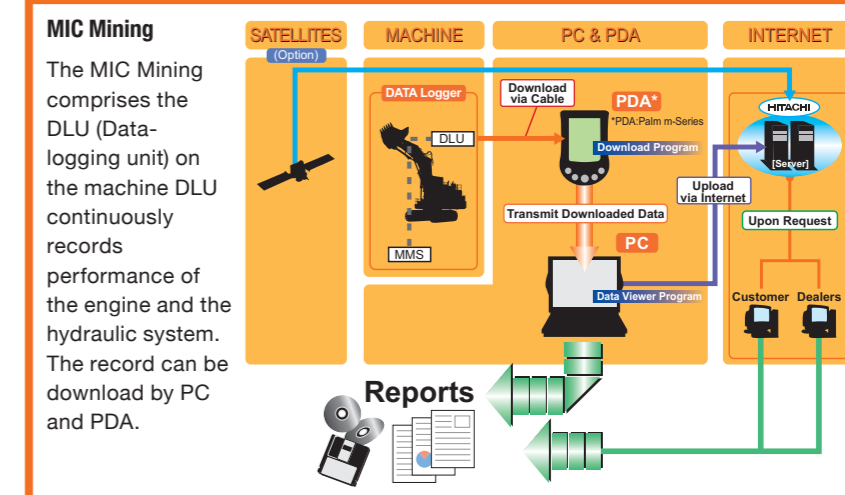

SPECIFICATIONS

WORKING RANGES

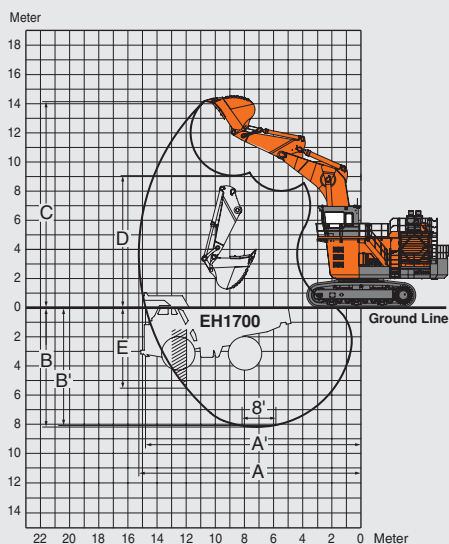

Backhoe

Boom length	m	8.30	8.70		11.80		
Arm length	m	3.60	4.00	5.50	4.00	7.00	
A Max. digging reach	mm	15 250	16 070	17 500	19 390	20 860	21 850
A' Max. digging reach (on ground)	mm	14 770	15 630	17 090	19 020	20 520	21 530
B Max. digging depth	mm	8 180	9 230	10 730	11 780	13 280	14 430
B' Max. Max. digging depth (8' level)	mm	8 070	9 120	10 640	11 670	13 190	14 350
C Max. cutting height	mm	14 140	14 480	15 010	17 380	18 140	17 900
D Max. dumping height	mm	9 060	9 200	9 810	11 820	12 660	13 200
E Max. vertical wall	mm	5 520	6 630	7 430	10 050	11 010	11 260

BE-boom length 8.30 m
 BE-arm length 3.60 m
 Bucket digging force
 ISO 671 kN (68 400 kgf)
 SAE: PCSA 617 kN (62 900 kgf)
 Arm crowd force
 ISO 620 kN (63 200 kgf)
 SAE: PCSA 609 kN (62 100 kgf)

Loading Shovel

11.0 m³
 A Min. digging distance
 5 550 mm
 B Min. level crowding distance
 7 650 mm
 C Level crowding distance
 4 820 mm
 D Max. digging reach
 13 430 mm
 E Max. cutting height
 14 610 mm
 E' Max. dumping height
 10 440 mm
 F Max. digging depth
 5 920 mm
 G Working radius at max.
 dumping height
 6 890 mm
 H Max. bucket opening width
 2 100 mm
 Arm crowding force
 11.0 m³ 710 kN (72 400 kgf)
 12.0 m³ 706 kN (72 000 kgf)
 15.0 m³ 719 kN (73 300 kgf)
 Breakout force
 11.0 m³ 660 kN (67 300 kgf)
 12.0 m³ 606 kN (61 800 kgf)
 15.0 m³ 612 kN (62 400 kgf)

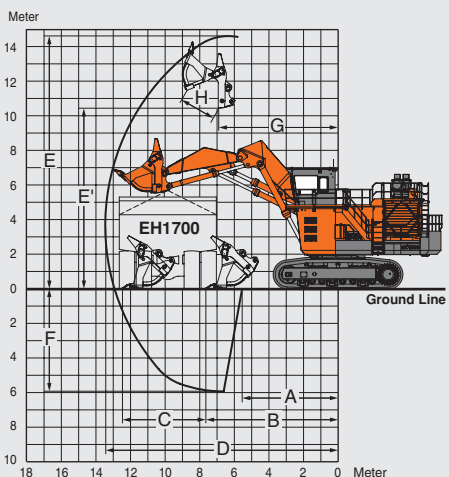

ENGINE

Model..... Cummins QSKTA38-CE
 Rated power
 DIN 6271, net 775 kW (1 054 PS) at 1 800 min⁻¹ (rpm)
 SAE J1349, net..... 775 kW (1 039 HP) at 1 800 min⁻¹ (rpm)
 SAE J1995, gross 810 kW (1 086 HP) at 1 800 min⁻¹ (rpm)
 Piston displacement..... 37.8 L
 Fuel tank capacity 4 140 L

HYDRAULIC SYSTEM

Main pumps..... 6 variable-displacement, piston pumps for front attachment travel and swing
 Pressure setting 29.4 MPa (300 kgf/cm²)
 Max. oil flow 6 X 335 L/min

UPPERSTRUCTURE

Swing speed 4.7 min⁻¹ (rpm)

UNDERCARRIAGE

Travel speeds High: 0 to 2.8 km/h Low : 0 to 2.1 km/h
 Maximum traction force 941.5 kN (96 000 kgf)
 Grade ability 60 % (30 degree) max.

WEIGHTS AND GROUND PRESSURE

Backhoe

Equipped with 8.3 m boom, 3.6 m arm, and 12.0 m³ (PCSA heaped) bucket

Shoe width	Operating weight	Ground pressure
800 mm	192 000 kg	184 kPa (1.88 kgf/cm ²)

Loading Shovel

Equipped with 11.0 m³ (PCSA heaped) bottom dump bucket

Shoe width	Operating weight	Ground pressure
800 mm	191 000 kg	183 kPa (1.87 kgf/cm ²)

ATTACHMENTS

Backhoe : Bucket Capacity (PCSA 1:1 heaped)

12.0 m³ / 9.6 m³ / 8.0 m³ / 6.0 m³ / 4.8 m³ / 4.4 m³ :
 Materials density 1 800 kg/m³

Loading Shovel : Bucket Capacity (PCSA 2:1 heaped)

11.0 m³ : Materials density 1 800 kg/m³
 12.0 m³ : Materials density 1 600 kg/m³
 15.0 m³ : Materials density 1 100 kg/m³

The number of wear plates and their installation positions on the bucket of loading shovel or backhoe vary depending on applications at job site. The installation of wear plates is indispensable.
 Consult your nearest Hitachi or Hitachi dealer for details.

DIMENSIONS

Unit: mm

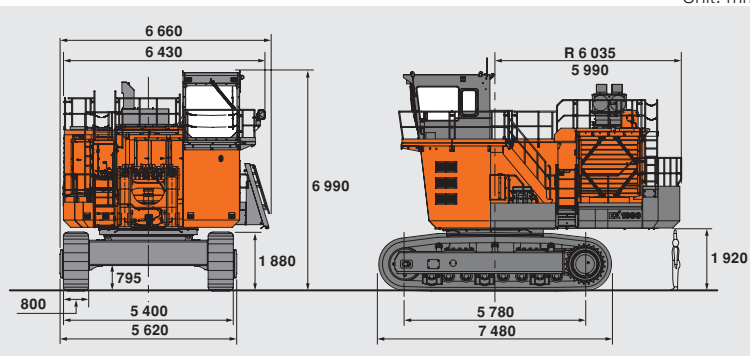

These specifications are subject to change without notice.

Illustrations and photos show the standard models, and may or may not include optional equipment, accessories, and all standard equipment with some differences in color and features.

Before use, read and understand the Operator's Manual for proper operation.

